

## Installation Instructions

### Road Defender Push Bumper Part # 5039-2L91

#### 2013 - 2016 Ford Interceptor Sedan

**Do not attempt to install this product on any vehicle other than the one listed above!**

Parts List				
Item	QTY	Code	Description	Max Torque
1	1 pc	5039-F	Push Bumper Body	
2	1 set	503921-22	Main bracket	
3	2 pcs	503925	Main bracket spacer	
4	1 set	503911-12	Clamp bracket	
5	1 set	503931-32	Upper extension bracket	
6	1 set	503951-52	Lower extension bracket	
7	2 pcs		1/2" Bolt plate	
8	2 pcs		1/2" Lock washer	
9	2 pcs		1/2" Hex nut	65 Lb Ft
10	1 pc		1/2" wire bolt guide	
11	16 pcs		3/8 x 1" hex bolt	
12	4 pcs		3/8 x 1" carriage head bolt	
13	20 pcs		3/8" Lock washer	
14	20 pcs		3/8" Hex nut	30 Lb Ft
15	1 pc	53422L910AA	Lighted bar assembly	
16	2 pcs	53422L910CA	Lateral light support	
17	2 pcs	53422L916CA	Auxiliary attachment bracket	
18	4 pcs	53422L913AA	Spacer plate	
19	4 pcs		1/4 x 2" allen head bolt	
20	2 pcs		1/4 x 1/2" allen head bolt	
21	2 pcs		1/4 x 1 3/4" allen head bolt	
22	2 pcs		1/4" lock washer	

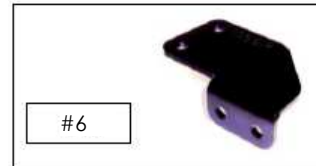

#### **Tool Required:**

1/8" Allen wrench  
 5,5mm, 8mm, 10mm , 1/4", 9/16" & 3/4" Socket  
 9/16" Wrench  
 Phillips & Slotted Blade Screw Driver  
 Ratchet & Ratchet Extension  
 Jig Saw or Dremel Tool  
 Tape Rule

**Approximated installation time: 45 min.**

**Read the installation instructions completely and verify that all of the parts listed are accounted for. If you have defective, missing or damaged parts or need assistance, please contact Go Rhino Products for fast, friendly customer service at: 1-888-427-4466 or email: warranty@gorhino.com**

To maintain and care this product keep it clean and do not use abrasive cleaners or polish waxes. It is recommended to use only non-abrasive automotive wax such as pure carnauba to avoid scratches and rust.

## Light Bar Assembly

1.- Insert the light in one of the rectangular holes of the light bar. **See photo 1.**

2.- Place the light bracket on top of the light, then push the light bracket to the left and fix the bracket with one 1/4 lock washer and 1/4" x 1/2" allen head bolt. **See photo 2 and 3.**

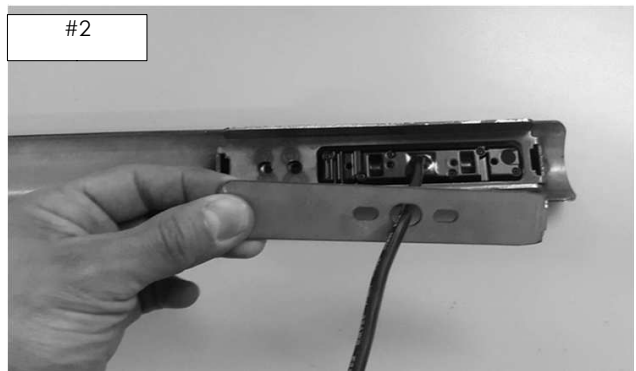
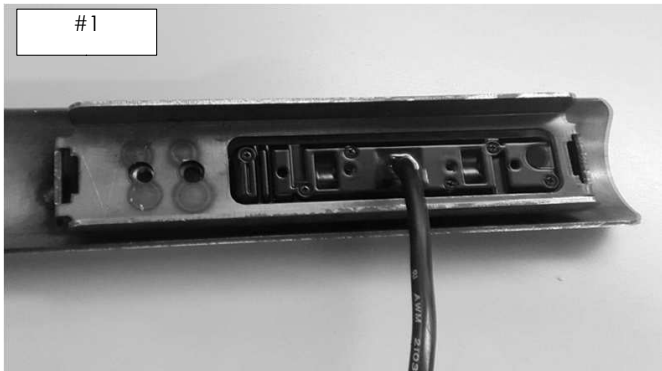

3. Repeat steps 1 & 2 for the other lights. **Note: Make sure that all the lights have the same orientation.**

4. Place one spacer plate over the light bracket and attach the light using the screws M3.5x10 (included with the light). **See photo 4 and 5.**

5. Refer to the installation and maintenance manual included with the lights to wire and configure the flash pattern. Note: Leave several feet of connector cable for connection to the light controller.

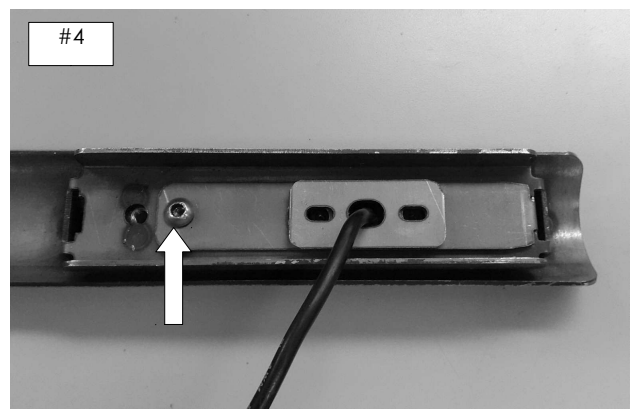
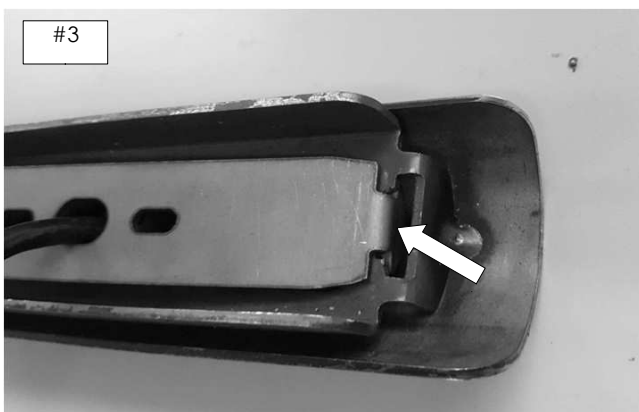

6. Feed the connector cable through the hole in the front bar channel and side panel until the hole in the push bumper center plate. Use the bolt guide attached to the side plate. **See image 6.**

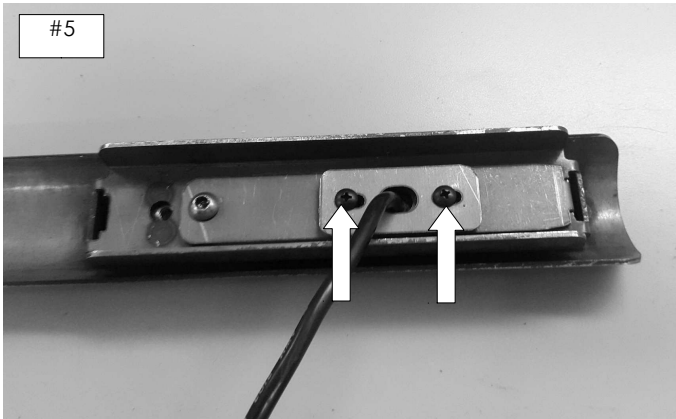

7. Place the lateral lights support in upright and attach using: (2) 1/4 x 2" Allen Head Bolt. Repeat for the other side. **See image 7.**

8. Secure the light bar assembly to the light bar tube using two 1/4"x1 3/4" allen head bolt. **See image 8.**

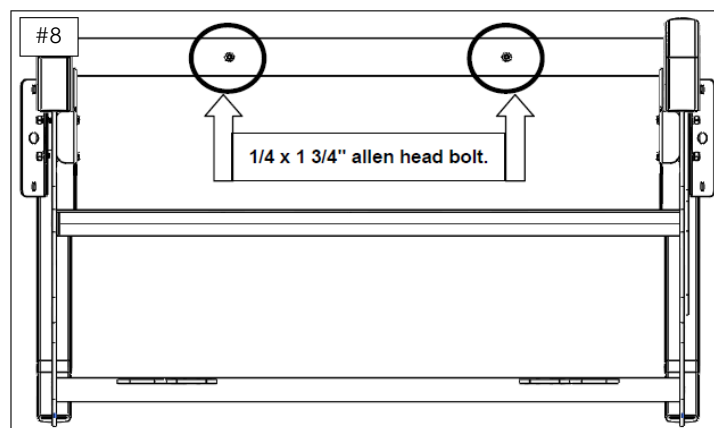
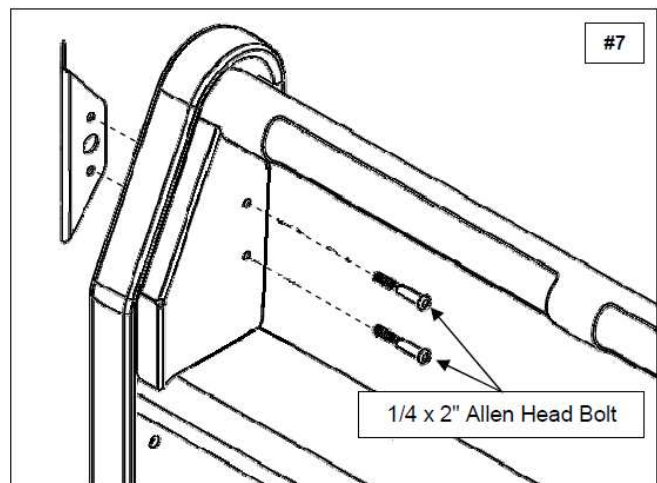
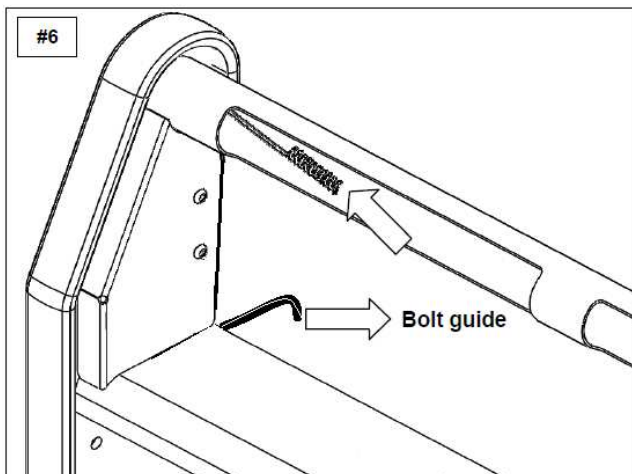

## Front Bumper Fascia Removal

1. Open the hood, locate and remove the (8) Phillips screws, (4) 10mm head screws and (2) plastic fasteners securing the radiator cover and bumper fascia to the radiator support. **Picture #1** Remove the radiator cover from the vehicle.
2. On each side, remove (1) Phillips screw, (2) 5.5mm head screws and (2) 10mm head screws attaching the fender liner to the fascia. **Picture #2**



3. Pull back the fender liner and remove the Phillips screw and plastic fastener attaching the fascia to the fender. **Picture #3**
4. Remove the (4) 8mm head screws attaching the rear of the splash shield to the radiator support. **Picture #4**

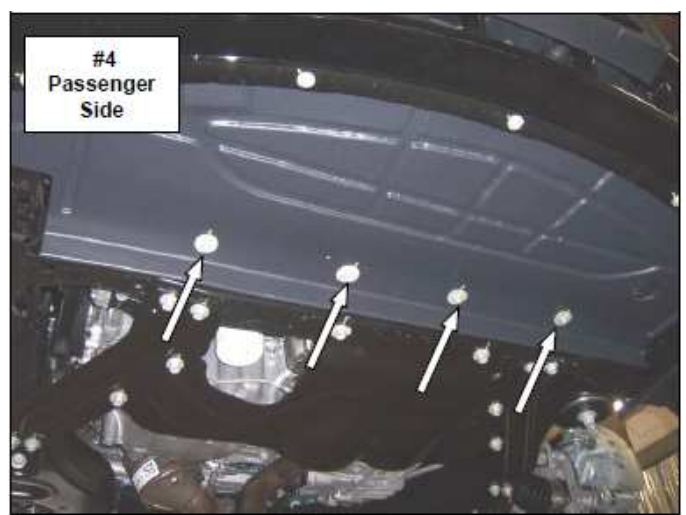

5. With assistance pull out on the sides to release the corners of the bumper fascia and forward to remove it from the vehicle.



## Push Bumper Installation

1. Beginning with the passenger side, install (1) 1/2" bolt plate in the outer hole in the face of the steel impact beam using the supplied wire guide. **Picture #5**
2. Position (1) spacer plate and the passenger side main bracket over the bolt plate, and secure the spacer plate and main bracket to the impact beam using (1) 1/2" lock washer and (1) 1/2" hex nut. Leave the nut loose for final adjustment. **Picture #6.** Repeat the above steps for the driver side.



3. Insert the top of the passenger side clamp bracket through the gap between the impact beam and auxiliary cooler, and then rotate the bracket into position. Slide the bracket to the left and align the holes in the clamp bracket with the main bracket. Secure the clamp bracket to the main bracket using (2) 3/8" x 1" carriage bolts, (2) 3/8" lock washers and (2) 3/8" hex nuts. **Picture #7 & #8** Leave the nuts and bolts loose for final adjustment.

**Note:** Position the wiring harness behind the clamp bracket.

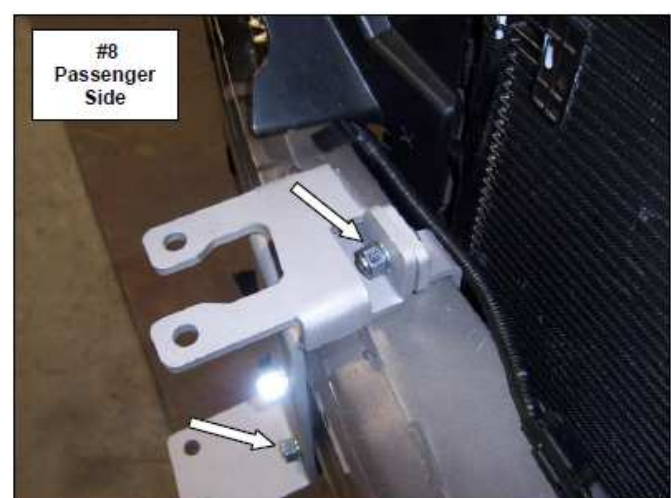

4. Position the driver side clamp bracket behind the impact beam and align the holes in the clamp bracket with the driver side main bracket. Secure the clamp bracket to the main bracket using (2) 3/8" x 1" carriage bolts, (2) 3/8" lock washers and (2) 3/8" hex nuts. **Picture #9 & #10** Leave the nuts and bolts loose for final adjustment.

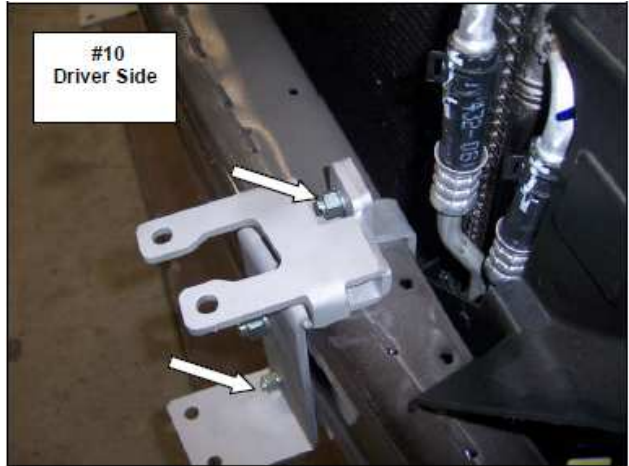
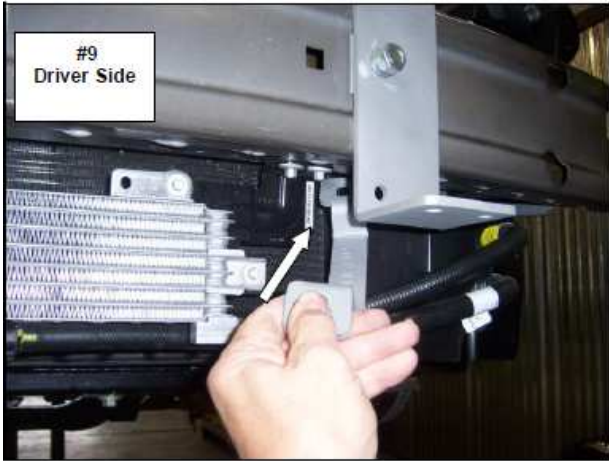

5. Position the top and bottom edge of the passenger side main bracket approximately 11 1/4" from the end of the impact beam and tighten the main and clamp bracket assembly nuts and bolts. Repeat this step for the driver side. **Picture #11 & #12**

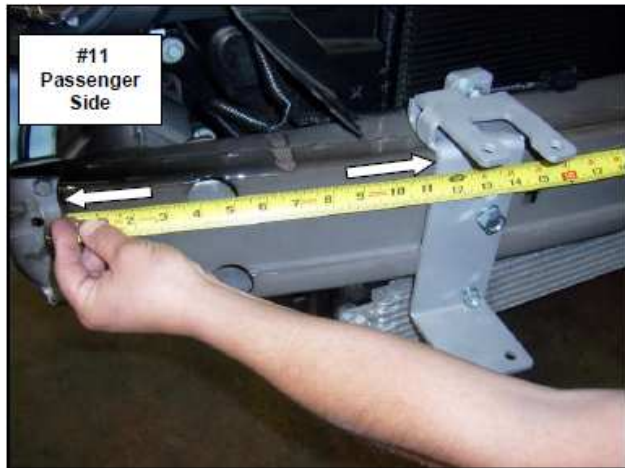

6. The bumper insulator must be notched (top and bottom) to properly fit around the main brackets. Remove the insulator from the bumper fascia and position the insulator up to the bumper and mark the main bracket locations. Notch the insulator and check fit by returning the insulator to the impact beam until the proper fit is achieved. **Picture #13 & #14**





7. Reinstall the bumper insulator to the fascia and bumper fascia to the vehicle. **Picture #15**

8. Attach the passenger side upper and lower extension brackets to the main bracket using (2) 3/8" x 1" hex bolts, (2) 3/8" lock washers and (2) 3/8" hex nuts. **Picture #16** Leave the nuts and bolts loose for final adjustment. Repeat this step for the driver side.



9. Attach the push bumper to each of the extension brackets using (2) 3/8" x 1" hex bolts, (2) 3/8" lock washers and (2) 3/8" hex nuts. Leave the nuts and bolts loose for final adjustment. **Picture #17 & #18**



10. Align the push bumper with the vehicle and tighten all nuts and bolts. **Picture #19 & #20**

