

Installation Instructions

Road Defender Push Bumper Part # 5342-4L71

2016 Ford Interceptor Utility

Do not attempt to install this product on any vehicle other than the one listed above!

Parts List				
Item	QTY	Code	Description	Max Torque
1	1 pc	5342-F	Push Bumper Body	
2	2 pcs	534222	Main bracket	
3	2 pcs	534010	Clamp bracket	
4	2 pcs	534031	Driver side extension bracket	
5	2 pcs	534032	Passenger side extension bracket	
6	24 pcs		3/8 x 1" hex bolt	
7	24 pcs		3/8" lock washer	
8	24 pcs		3/8" hex nut	30 Lbs Ft
		4L71M1-TK	Bracket kit light mask	
9	1 pc	4L71-M1	Lighted bar assembly	
10	4 pcs	50776FB	Auxiliary attachment bracket	
11	2 pcs	50770NA	Lateral lights support	
		KTE-4L71M1	Hardware bolt kit	
12	4 pcs		1/4 x 2" Allen Head Bolt	10 Ft. Lbs.
13	4 pcs		1/4 x 1/2" Allen Head Bolt	10 Ft. Lbs.
14	2 pcs		1/4 x 1 3/4" Allen Head Bolt	10 Ft. Lbs.
15	4 pcs		1/4" Lock Washer	

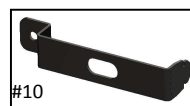
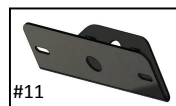

Tool Required:

1/8" Allen wrench
 8mm, 10mm, & 9/16" Socket
 9/16" Wrench
 Philips & Slotted Blade Screw Driver
 Ratchet & Ratchet Extension
 Utility Knife
 Tape Rule

Approximated installation time: 60 min.

Read the installation instructions completely and verify that all of the parts listed are accounted for. If you have defective, missing or damaged parts or need assistance, please contact Go Rhino Products for fast, friendly customer service at: 1-888-427-4466 or email: warranty@gorhino.com

To maintain and care this product keep it clean and do not use abrasive cleaners or polish waxes. It is recommended to use only non-abrasive automotive wax such as pure carnauba to avoid scratches and rust.

Light Bar Assembly

1. Insert the light in one of the rectangular holes of the light bar. **See photo 1.**
2. Place the light bracket on top of the light, then push the light bracket to the left and fix the bracket with one 1/4 flat washer and 1/4" x 1/2" allen head bolt. **See photo 2 and 3.**

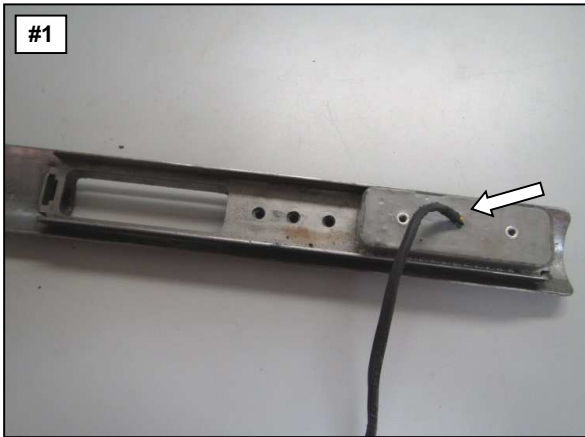

3. Repeat steps 1 & 2 for the other lights. **Note: Make sure that all the lights have the same orientation.**
4. Refer to the installation and maintenance manual included with the lights to wire and configure the flash pattern. Note: Leave several feet of connector cable for connection to the light controller.
5. Feed the connector cable through the hole in the front bar channel and side panel until the hole in the push bumper center plate. Use the bolt guide attached to the side plate. **See photo 6.**

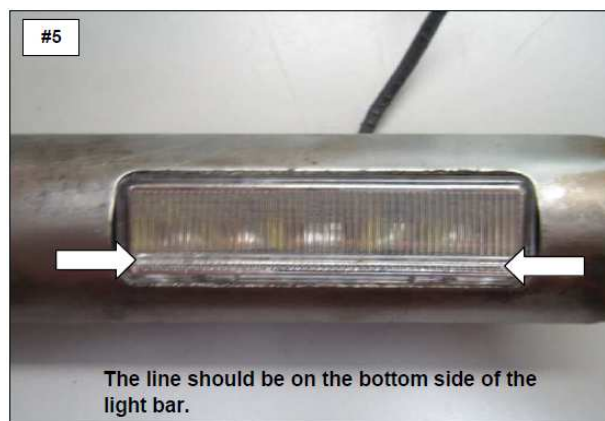
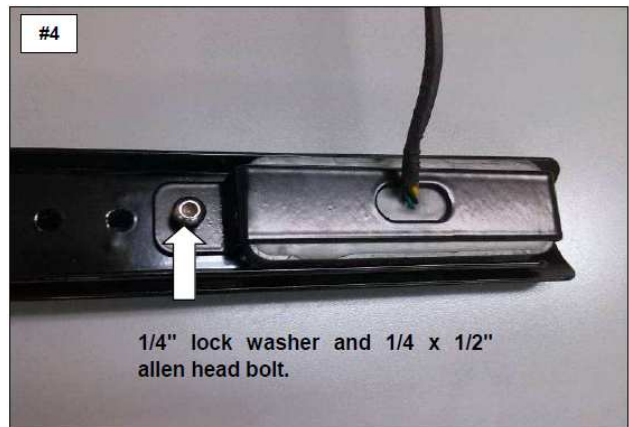

6. Place the lateral lights support in upright and attach using: (2) 1/4 x 2" Allen Head Bolt. Repeat for the other side. **See photo 7.**

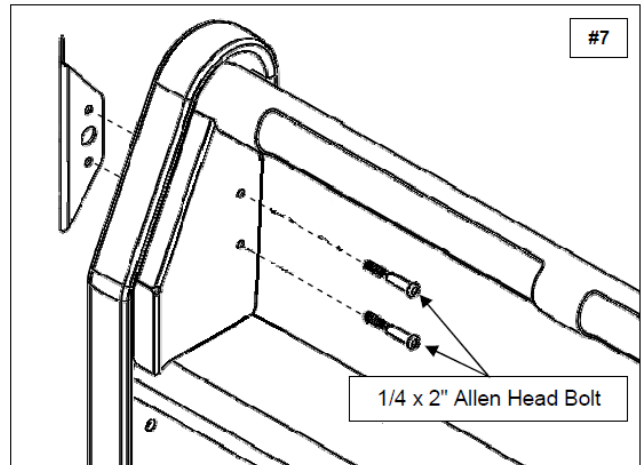
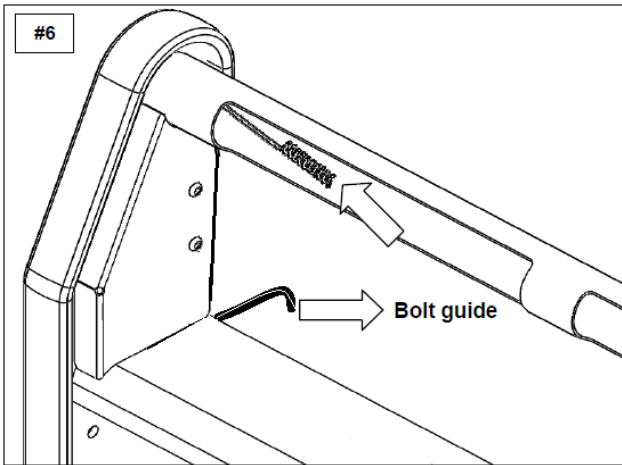

7. Secure the light bar assembly to the light bar tube using two 1/4"x1 3/4" allen head bolt. **See photo 8.**

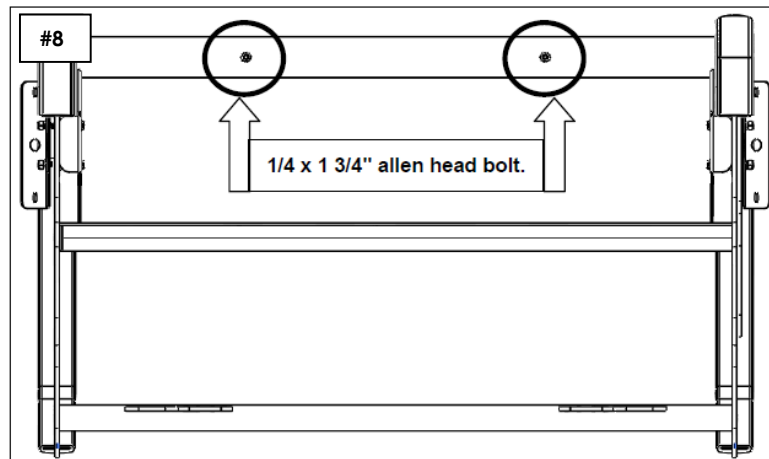

Front Bumper Fascia Removal

1. Open the hood, locate and remove the plastic connectors securing the radiator cover and hex bolts securing the top of the front bumper fascia.
2. On each side, remove the screws securing the fender liner and fender molding to the front bumper fascia. Pull the fender liner back to expose and remove the bolts securing the front bumper fascia to the front fender.
3. On each side remove the screws securing the fender liner to the bottom of the front bumper fascia.
4. Remove the bolts securing the bottom center of the front bumper fascia to the core support.
5. With assistance pull out on the sides to release the corners of the front bumper fascia and forward to remove it from the vehicle. **Note:** Unplug the fog lights if equipped.



6. Remove the (4) hex bolts securing the oil cooler, to allow access for placement of the main brackets behind the impact beam.

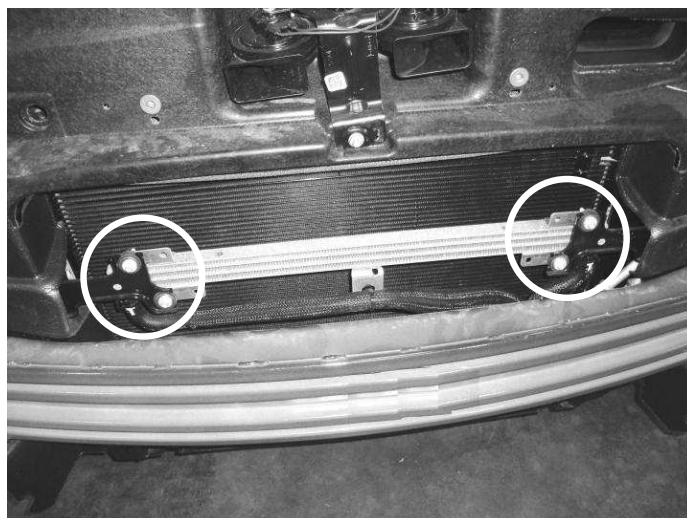

Push Bumper Installation

1. Beginning with the passenger side, assemble and attach one of the main and clamp brackets to the steel impact beam using (4) 3/8" X 1" hex bolts, (4) 3/8" lock washer and (4) 3/8" hex nuts. Position the top and bottom edge of the bracket assembly approximately 11 3/4" from the end of the impact beam and tighten the nuts and bolts, (Photo 1 & 2). Repeat this step for the driver side.

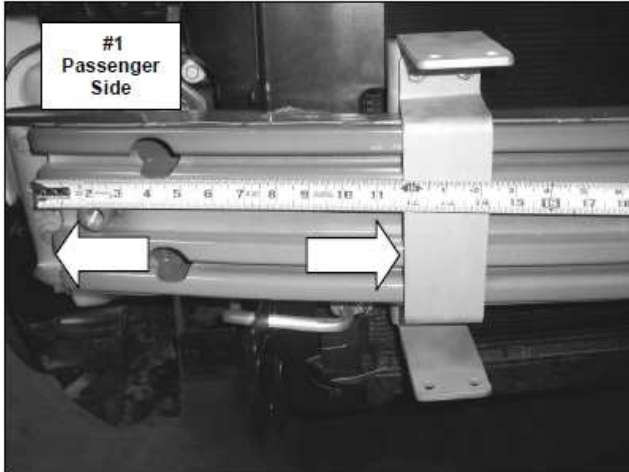

2. Reinstall the oil cooler using the factory bolts.

3. A section of webbing in each side of the lower grille must be cut out for the lower leg of the main brackets to extend through. Re-position the fascia on the vehicle, then cut and remove the webbing from each side of the lower grille as shown, (Photo 3).

4. Reinstall the front bumper fascia reversing the above steps, and that the main bracket protrude through the fascia, (Photo 4).

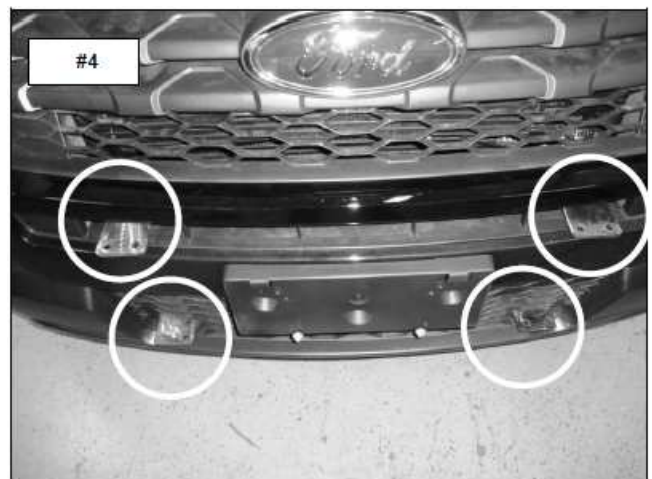
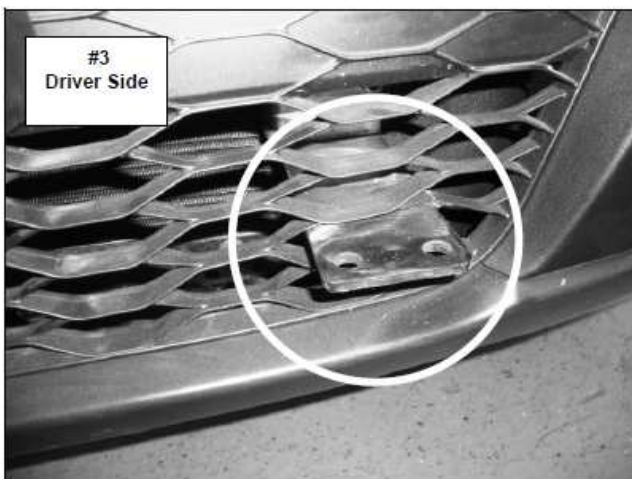

5. Attach each of the passenger side extension brackets to the main bracket using (2) 3/8" x 1" hex bolts, (2) 3/8" lock washers and (2) 3/8" hex nuts, (Photo 5). Leave the nuts and bolts loose for final adjustment. Repeat this step for the driver side, (Photo 6).

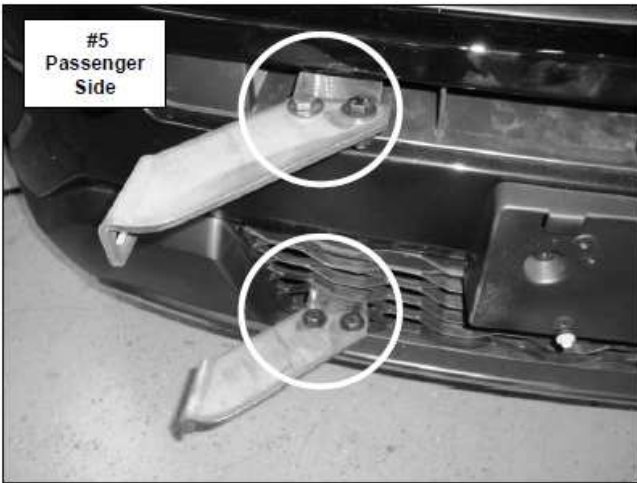

6. Attach the push bumper to each of the extension brackets using (2) 3/8" x 1" hex bolts, (2) 3/8" lock washers and (2) 3/8" hex nuts, (Photo 7 & 8). Leave the nuts and bolts loose for final adjustment.

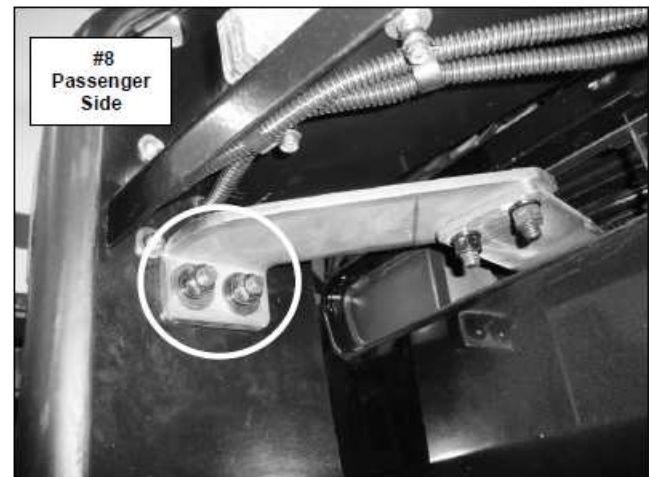
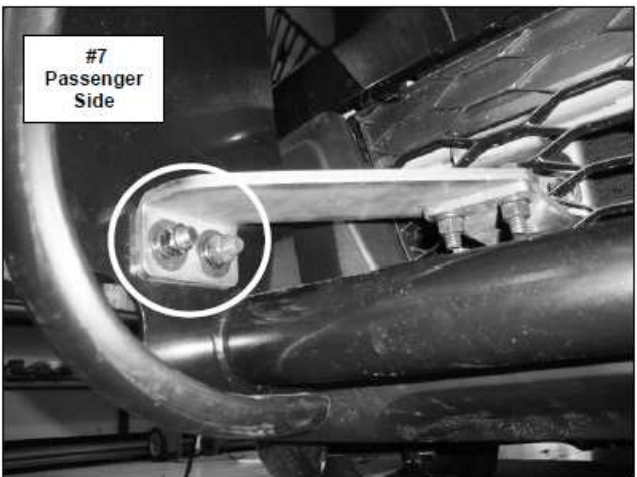

7. Align the push bumper with the vehicle and tighten all nuts and bolts, (Photo 9 & 10).

