

GORRHINO®

INSTALLATION INSTRUCTIONS

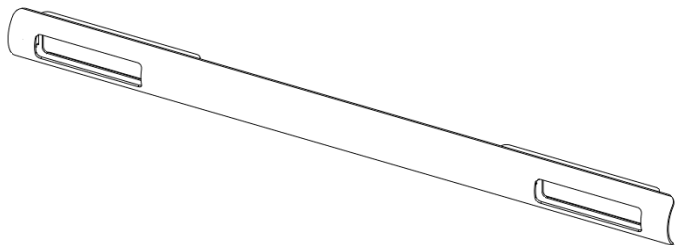

PART NO.

- 2L91-M1B

PRODUCT DESCRIPTION:

- ROAD DEFENDER LIGHT MASK

APPLICATION:

- CODE 3 MR6

PRODUCT SAFETY & LEGAL DISCLAIMER

- **IMPORTANT READ ALL INSTRUCTIONS CAREFULLY BEFORE INSTALLING, FAILURE TO DO SO MAY CAUSE PERSONAL INJURY OR DAMAGE TO PRODUCT AND/OR PROPERTY.**
- **Review the product package and contents prior to beginning the installation.** Take care when opening the packaging and removing items. If a return is needed you will want to return the product in its original packaging if possible.
- This instruction guide is provided as a GENERAL installation guide, some vehicles vary dimensionally and may require additional steps.
- Test fit the product on the vehicle prior to any third party modifications and or finishing. The manufacturer and/or distributors do not accept responsibility for third party charges, labor and or third part replacement modifications. Some modifications may void the factory warranty.
- Exercise due-diligence when installing this product. The manufacturer and distributors of this product do not accept any responsibility for vehicle damage or personal injury resulting from the installation of this product. Careless installation and operation can result in serious injury or equipment damage.
- This product is for general off-road use. All liability for installation and use rests with the owner/operator.
- **INSTALLER:** Once installation is complete, please return this guide along with other documentation included in this product back to the consumer for future reference. The manufacturer/distributors of this product do not guarantee this particular version will be available at a later date.

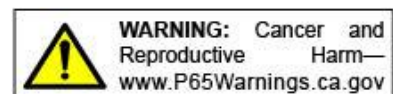

© 2016 Go Rhino Products. All rights reserved

www.gorhino.com

589 W. Apollo St., Brea, CA 92821

P: 888 427 4466

GO RHINO®

INSTALLATION INSTRUCTIONS

PARTS INCLUDED IN THIS LIST:

ITEM	QTY.	PART NUMBER	DESCRIPTION	TORQUE	ITEM	QTY.	PART NUMBER	DESCRIPTION	TORQUE
A	1	2L91-M1B	Lighted Bar Assembly		F	4		1/4 x 2" Allen Head Bolt	10 ft-lbs
B	2	53422L916CA	Light Mounting Bracket		G	2		1/4 x 1/2" Allen Head Bolt	10 ft-lbs
C	2	53422L910CA	Lateral Lights Support		H	2		1/4 x 1 3/4" Allen Head Bolt	10 ft-lbs
D	2	50774L516BA	Support Bracket		I	2		1/4" Lock Washer	
E	2	53422L913AA	Spacer plate						

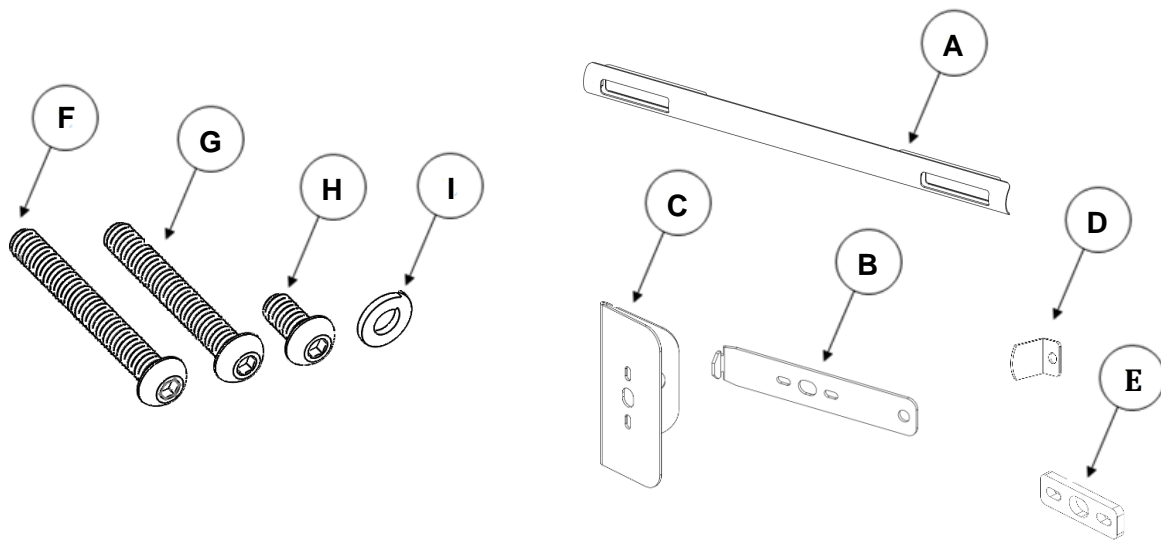

Go Rhino recommends you, the installer, read this installation instruction manual from front to back before installing the product. You may also [click here](#) to view an installation video or visit <http://www.gorhino.com/Installation-Videos>.

TOOLS NEEDED FOR INSTALLATION:

- 7/16" Socket & Wrench
- 5/32" Hex Key
- Ratchet, Ratchet Extensions

ESTIMATED TIME FOR INSTALLATION:

1.5 Hour

If you need installation service for your new product, call the authorized distributor from whom you purchased the product or an authorized installation service company which can be found by calling toll free 1-888-427-4466

GO RHINO®

INSTALLATION INSTRUCTIONS

Light Bar Assembly

Step-1 Insert the light in one of the rectangular holes of the light bar. See figure 1.

Step-2 Place the light bracket on top of the light, then push the light bracket to the left. Place (1) support bracket and secure the assembly using (1) 1/4" lock washer and (1) 1/4" x 1/2" allen head bolt. See figure 2, 3 & 4. **NOTE:** Place (1) support bracket to each extreme of the lighted bar.

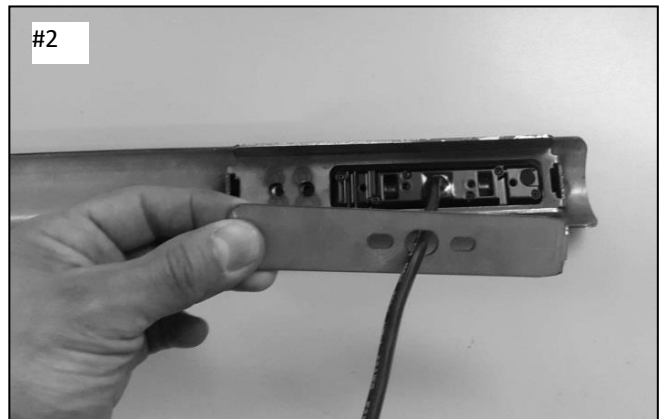
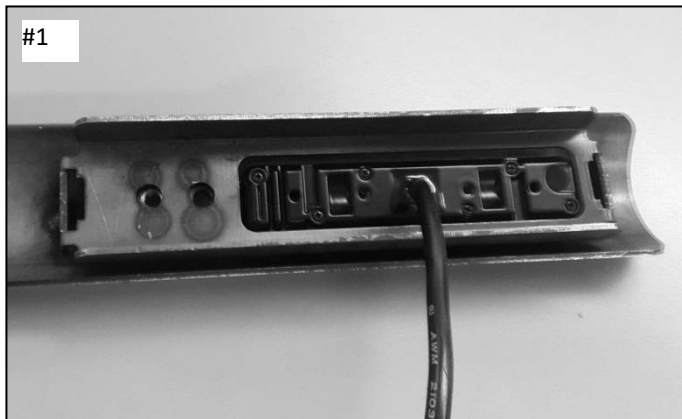

Step-3 Place one spacer plate over the light bracket and attach the light using the screws M3.5x10 (included with the light). See figure 5.

Step-4 Repeat steps 1, 2 & 3 for the other light. **Note: Make sure that all the lights have the same orientation.**

Step-5 Refer to the installation and maintenance manual included with the lights to wire and configure the flash pattern. **Figure 5.** Note: Leave several feet of connector cable for connection to the light controller.

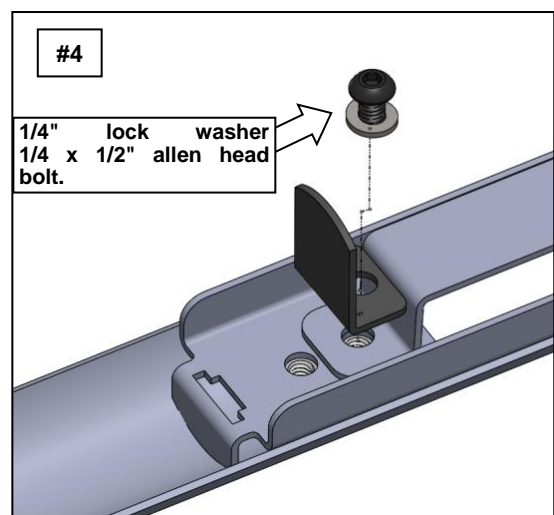

GO RHINO®

INSTALLATION INSTRUCTIONS

Step-6 Feed the connector cable through the hole in the bottom of the top tube until the hole in the push bumper center plate. **Figure 7.**

Step-7 Place the lateral lights support in upright and attach using: (2) 1/4 x 2" Allen Head Bolt. Repeat for the other side. **See figure 8.** **Note:** If you do not want to install the lateral lights support, attach with: (2) 1/4 x 2" Allen Head Bolt, (2) 1/4" flat and lock washers, (2) 1/4" hex nuts by each side.

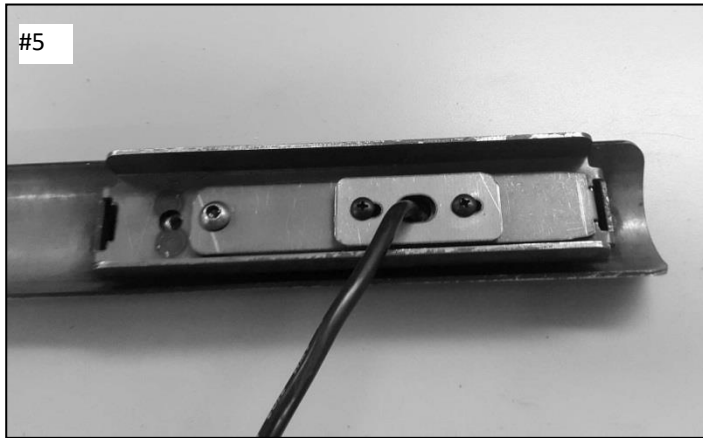

Step-8 Secure the light bar assembly to the light bar tube using two 1/4"x1 3/4" allen head bolt. **See figure 9.**

